

Modeling fluctuation of *Pyricularia grisea* spore population as affected by meteorological factors in Guilan province (Iran) using artificial neural network

Shideh Mojerlou, Sedigheh Mousanejad and Naser Safaie*

Department of Plant Pathology, College of Agriculture, Tarbiat Modares University, Iran, Tehran.

Abstract: Rice blast, caused by *Pyricularia grisea*, is one of the most important diseases of this crop in Iran and all over the world. To evaluate the relationship between spore population (SP) and meteorological factors, SP was measured daily using spore trap during growing seasons of 2006-2008 in Rasht and Lahijan regions (Guilan province, Iran). Weather data including precipitation, daily maximum and minimum temperatures, daily maximum and minimum relative humidity and duration of sunny hours were obtained from weather stations which were five kilometers away from the fields. The relationship between spore population and meteorological factors was evaluated by Neurosolution 5.0 software. Weather data and spore population were considered as input and output data, respectively. In this study, multilayer perceptron neural network, regression model and $\text{Log}(x + 1)$ transformation were performed. To evaluate the model efficiency, correlation coefficient and mean square error were used. The results showed that the correlation coefficient (r) and mean square error (MSE) parameters were 0.55 and 0.03 in Rasht and 0.1 and 0.03 in Lahijan, respectively. The results also showed the potential of this model for modeling SP using meteorological factors; however more data is needed for validation of this model. There has been no previous report on modeling the relationship between SP and meteorological data using artificial neural network in Guilan province (Iran).

Keyword: artificial neural network, blast, forecasting, *Pyricularia grisea*, rice

Introduction

Rice is Iran's second most important crop, providing staple food for the majority of population. Various hazardous factors including pests, diseases, weeds, drought, and also damages during harvest and storing period, impose heavy losses to rice annually. Rice blast, caused by *Pyricularia grisea* (Hebert) Barr, is considered to be the most important disease in Iran resulting in severe losses to

susceptible rice cultivars. Despite the availability of resistant varieties to blast and their increased cultivation in recent years, Iranian farmers still prefer the susceptible local varieties due to their more superior qualities (Javan Nikkhah, 2001). Meanwhile, In order to control the disease, farmers apply fungicides frequently without proper planning and timing which adversely affect the sustainable agricultural system. To provide an effective fungicide application program, it is necessary to evaluate the key factors involved in disease progress to develop a forecasting system. Many factors influence the blast severity including varietal susceptibility, date and space of

Handling Editor: Dr. Fakhtak Taliey

* **Corresponding author**, e-mail: nsafaie@modares.ac.ir
Received: 15 October 2012, Accepted: 25 February 2013

transplanting, amount of applied N fertilizer and meteorological factors such as relative humidity, temperature, precipitation, dew, velocity and direction of the wind and hours of sunshine (Calvero *et al.*, 1996). Thus, to introduce a forecasting model, it is essential to consider the effects of these factors on spore population leading to severe disease occurrence.

Many researchers have attempted to develop a forecasting model based on spore population (Kuribayashi and Ichikawara, 1952; Ono, 1965; Kim, 1982) and meteorological factors (Ono, 1965; El Refaei, 1977; Yoshino, 1971; Kingsolver *et al.*, 1984; Kim *et al.*, 1987; Padmanabham, 1965 and Calvero *et al.*, 1996).

Some of the complicated forecasting models are based on weather, spore catch, disease parameters and host plant criteria. For example a method to predict the number of leaf blast lesions per plant using multiple criteria that was developed in Korea (Kim *et al.*, 1975). Kingsolver *et al.* (1984) presented multiple regression equations for predicting the number of leaf blast lesions for different inoculum densities or different varieties. Other researchers in Japan (Muramatsu and Koyanagi, 1977; Kono, 1977; Shimizu, 1980; Hashiguchi and Kato, 1983) also tried to develop statistical methods, such as multiple regression analysis, for quantitative forecasting.

Neural networks are powerful sets of methods for solving problems of pattern recognition, data analysis and nonlinear control. They include benefits of high processing speeds and the ability of learning. Also they are complementary to conventional methods. A feed forward neural network can be considered as a nonlinear mathematical function which transforms a set of input variables (Fig. A. 1). A set of parameters called weight do the transformation and the process of determining these parameters is called learning or training. Once the weight have been fixed, new data can be processed by the network (Bishop, 1995). The disadvantages of neural network are: it needs suitable set of data for training and if there are considerable differences between training data and inputs of new regions, the

neural network will have a lot of potential problems. It has also been suggested that the neural network should be considered as possible candidate for solving traditional problems (Bishop, 1995).

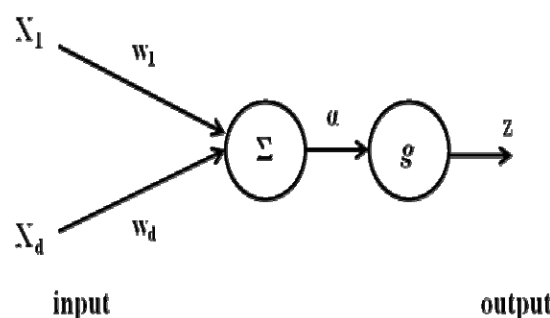

Figure 1 The McCulloch-Pitts model of single neuron forms a weighted sum of the inputs X_1, \dots, X_d given by $a = \sum_i w_i x_i$ and then transforms this sum using a non-linear activation function $g(a)$ to give a final output $z = g(a)$

Artificial neural network (ANN) is one of the useful methods in ecological modeling. It can learn, adapt and generalize the relations. ANN can be used for multivariate data sets which have nonlinear dependencies and variables do not have to fit any theoretical distribution (Fausett, 1994; Lek and Guegan, 1999; Grinn-Gofron and Strzelczak, 2008). Therefore, it is useful for forecasting airborne fungal spore distribution (Grinn-Gofron and Strzelczak, 2008).

A better understanding of the relative importance of the relationship between meteorological factors and spore population would help disease forecasting. The problem in the modeling of airborne fungal spore population is in part due to the limitation of statistical methods. Common methods such as, linear or multiple regression, are based on assumptions of linearity and normality, which often can not be fulfilled even after variable transformation. Thus, the achieved models are insufficient. This situation is typical for time series with short spore dispersal seasons. Therefore verifying other statistical techniques are essential to overcome these problems (Grinn-Gofron and Strzelczak, 2008).

ANN has been applied for classification, optimization, and prediction of problems in agricultural sciences (Cook and Wolfe, 1991; Thai and Shewfelt, 1991). In the past few years, ANN method has been used for cereal grain classification and identification tasks (Visen *et al.*, 2002). Applied research in plant pathology includes the prediction of leaf wetness duration (Francle *et al.*, 1995; Francle and Panigrahi, 1997; Chtioui *et al.*, 1999) and soybean rust progress (Yang *et al.*, 1995). Also, it has been applied to the prediction of disease intensity (Dewolf and Francle, 1997; Batchelor *et al.*, 1997). ANN method has performed as well as or better than traditional multivariate approaches for classifying incidence (Dewolf and Francle, 2000) and detecting infection periods of tan spot of wheat (Dewolf and Francle, 1997) and for prediction of wheat scab epidemics (Yang and Batchelor, 1997).

The aim of our study was to examine the relationship between *P. grisea* spore populations and meteorological factors in Guilan province using ANN, as a novel data analysis technique.

Materials and Methods

Data collection and recording

In order to introduce a forecasting model for rice blast disease in Guilan province, it was necessary to determine key factors affecting the disease epidemic. In this research, during growing seasons of 2006–2008, some fields located in a distance of around five kilometers from weather stations in two regions of Guilan province including Rasht and Lahijan were chosen for study. The daily airborne spore population in these fields was measured using spore traps. Spore traps used in this research included a wooden stand of 1.5 m height on which two rows of microscope slides (five slides per row) were placed on two pieces of glass (10 × 20 cm). Four spore traps were used for each field in the regions and these stands were placed in four geographical directions. Each slide was covered with Vaseline to adsorb the airborne spores (Amponsah *et al.*, 2009;

Lue *et al.*, 2007). Slides were collected every evening and the trapped spores counted under light microscope (100x). Meteorological data obtained from weather stations included daily precipitation (P), maximum and minimum daily temperature (T_{\max} , T_{\min}), maximum and minimum humidity (Rh_{\max} , Rh_{\min}), wind speed and duration of sunny hours (SH).

Data analysis

Multiple regression models could not be used for analysis of spore circulation due to nonlinear and non-normal distribution (Grinn-Gofron and Strzelczak, 2008). Therefore, ANN models with Multilayer perceptrons (MLP) architecture were used to determine the relationship between spore population and meteorological variables. One input layer, one hidden layer with 10 neurons and one output layer were selected for performing analysis with Neurosolution 5.0 software. Meteorological parameters used as input variables included precipitation, daily maximum and minimum temperatures, daily maximum and minimum relative humidity and duration of sunny hours. Spore population was the output variable. In the applied network, 80 percent of data were considered for network training and the rest for testing. Training used back propagation (Fausett, 1994; Haykin, 1994; Patterson, 1996; Grinn-Gofron and Strzelczak, 2008) and conjugate gradient algorithms (Bishop, 1995; Grinn-Gofron and Strzelczak, 2008). The network was trained with 1000 epochs of back propagation. Due to rapid changes in spore concentration, $\log(x + 1)$ transformation was applied to spore counts data (Grinn-Gofron and Strzelczak, 2008).

Results and Discussion

In this study, the ANN was used due to nonlinear distribution of spores (Fig. 2). The ANN model obtained with the transformed *P. grisea* spore counts ($\log(x + 1)$) as output variable was an MLP network with one input layer, one hidden layer with 10 neurons and one

output layer (MLP 1: 1-10-1:1), trained with 1000 epochs of back propagation. The correlation coefficient (r) and mean square of error (MSE) were 0.55 and 0.03 in Rasht and 0.1 and 0.03 in Lahijan, respectively. Comparison of the observed and predicted outputs by ANN model (Fig. 3) showed good fitness of the model.

Tsai (1986) and Tsai and Su (1984) collected data on rice leaf blast progress and weather factors during 1979-1984 in Taiwan and introduced several multiple regression equations to predict infected leaf area percentage. Uehara (1985) applied multivariate statistical analysis techniques such as principal components and cluster analysis to classify regions according to the degree of occurrence of leaf and panicle blast. Kim *et al.* (1987, 1988) developed an algorithm to index weather in respect to blast suitability. Sometimes the blast disease is predicted using a combination of factors. For example forecasting can be based on weather and spore catch. El Refaei (1977) applied data from blast nursery trials to develop several linear regression equations that separately relate the number of lesions per seedling to weather variables (dew period, mean day or night temperature, mean day or night RH and rainfall) and airborne inoculum density. Other researchers also have used this approach (Chien *et al.*, 1984; Tsai and Su, 1985). Tsai (1986) and Tsai and Su (1984) included data on spore catch on several rice varieties.

Many researchers in Japan (Muramatsu and Koyanagi, 1977; Kono, 1977; Shimizu, 1980; Hashiguchi and Kato, 1983) have also tried to develop statistical methods, such as multiple regression analysis, for quantitative forecasting. The independent variables were date of initial leaf blast occurrence, plant height, tillers per hill, percent diseased plants on 15 July (the early stage of the leaf blast epidemic), cumulative number of spores trapped from transplanting to 15 July, monthly mean temperature and precipitation, plant height in late June and minimum temperature or duration of sunshine in July and August.

Figure 2 shows the daily spore population in the two regions of our study. Three peaks of spores were recognized in these regions. The first peak of spores started on June 16 and finished on June 22 in both regions. The second peak started on July 12 and finished on July 17 in Rasht and July 14 in Lahijan. The third peak started on July 24 and finished on July 28. The spore population and meteorological factors fluctuations were considered together in these regions to find out the relationship between these two phenomena. fluctuations of weather factors are shown in Figs. 4, 5 and 6. In Rasht (Fig. 6) precipitation was 9.2 and 3.6 mm on June 12 and 13, respectively, and during these days, daily T_{\max} decreased from 30 °C to 25–27 °C, while the daily T_{\min} did not decrease, but increased as much as 1–2 °C reaching 20 °C. The daily RH_{\min} also increased by 7–10 %, but daily RH_{\max} did not change much. Also during this period, sunny hours were 0–1.5 h per day and it was mostly cloudy. The second peak of spores in Rasht started on July 12. Considering the weather factors before this peak, there was 27.1, 29.5, 9.1, 1.3 and 0.1 mm precipitation on July 3–6 and 11 respectively, the decrease of daily T_{\max} by 5–7 °C and the increase of daily RH_{\min} by 30–40 %, but daily T_{\min} did not change much. Some days before the third peak of spores in Rasht, weather factors followed the same changes, but with less consistency. Thus, spore population did not increase much and a small peak occurred.

In Lahijan (Fig. 6), some days before the observation of first peak of spores, on June 12 and 13, some precipitation occurred. Also during this period, daily T_{\max} decreased by 1–4 °C, daily RH_{\min} increased by 10–30 % and sunny hours reached 0.3–3.3 h per day. These conditions lead to the increase of airborne spore population some days later. Also on July 3–6, precipitation was 24.2, 13.7, 2.6 and 0.7 mm respectively, and during these days, daily T_{\max} decreased by 4–9 °C, daily RH_{\min} increased by 20–50% and sunny hours reached zero. These changes resulted in the increase of airborne spore population 4–5 days later. This good relationship was also observed for the third peak.

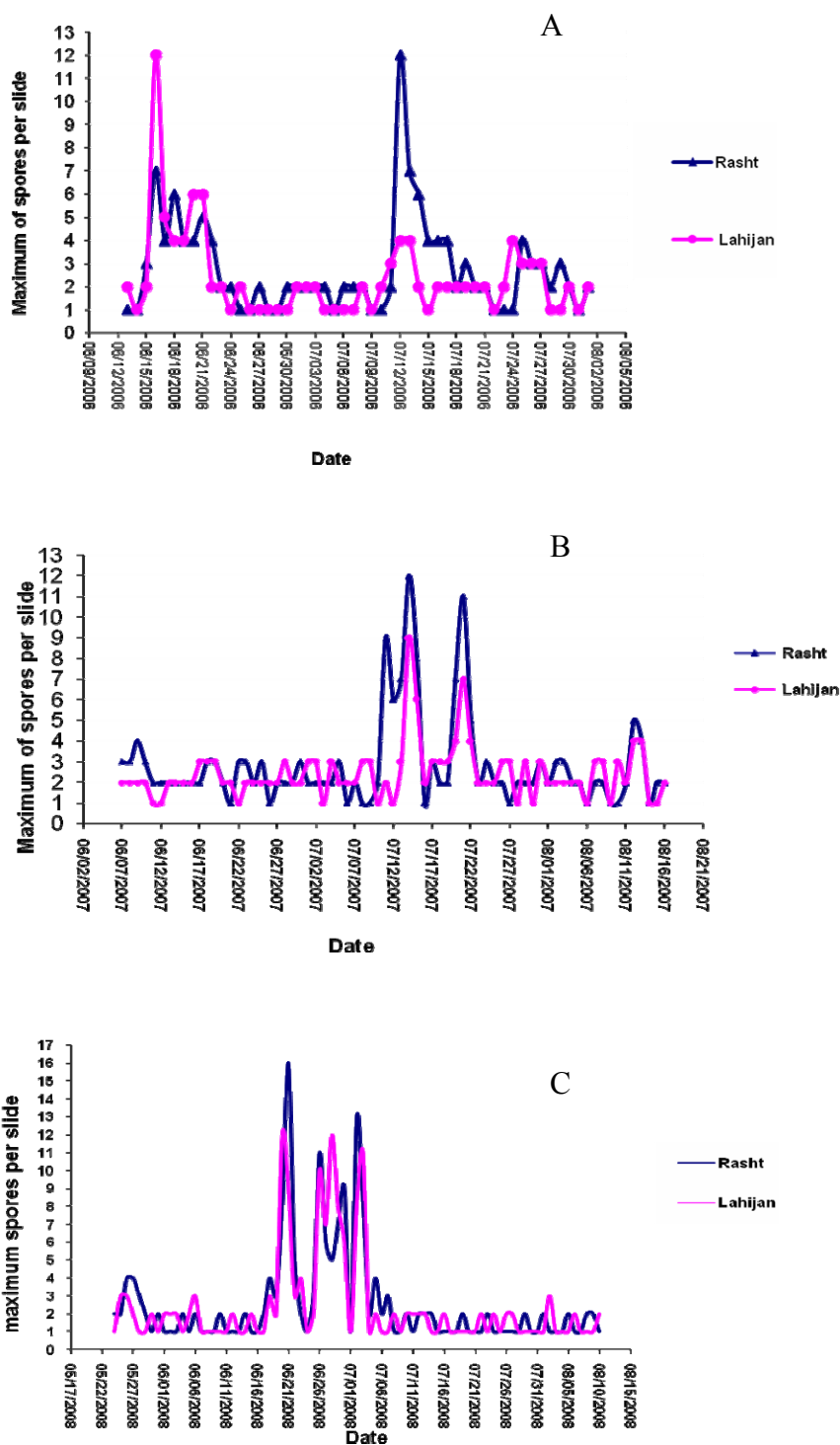

Figure 2 The comparison of the trapped spore population in Rasht and Lahijan in 2006 (A), 2007 (B) and 2008 (C).

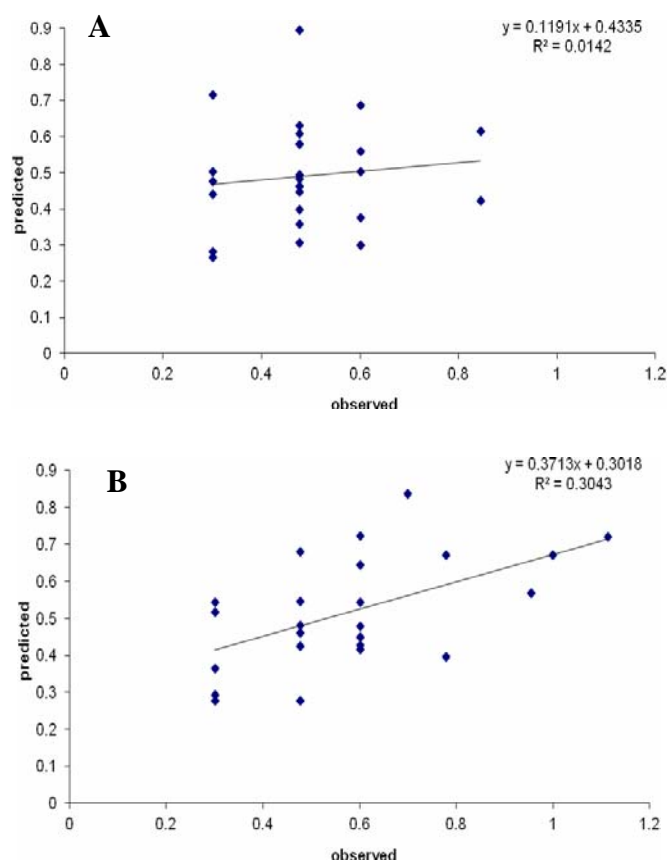

Figure 3 Scatter plot of the relationship between observed and predicted output by ANN model in Lahijan (A) and Rasht (B).

We can't interpret some differences in the meteorological factors fluctuation between Rasht and Lahijan, because they are equidistant from the sea. It is interesting that, the dates of starting and finishing the peaks in Rasht and Lahijan were consistent with the dates of starting and finishing favorable weather conditions (for example compare the first peak in Rasht with Lahijan). Mousanejad *et al.* (2009) showed that the key weather factors for predicting spore peaks and consequently the occurrence of rice blast epidemic in Guilan province are precipitation, daily T_{max} , daily RH_{min} and SH, meanwhile factors such as daily T_{min} and daily RH_{max} are less important. Their results indicated that higher spore population occurred 3–5 days after precipitation or when there were:

decrease or increase of daily T_{max} reaching 26–28 °C, increase of daily RH_{min} reaching 60–70 % and decrease of SH reaching less than 1–3 h per day. These conditions lead to the occurrence of blast lesions and increased blast incidence and severity (on leaves and panicle necks) 7–10 days after suitable weather conditions. These results are consistent with the results of studies done by Esmailpoor (1980), Izadyar (1983) and other studies conducted in other rice growing areas for forecasting blast disease, based on factors like precipitation, decrease of daily temperature, the increase of daily RH and decrease of sunny hours (Tsai *et al.* 1985). Results of this study help to predict blast disease in Guilan province and to provide suggestions about the date and frequency of fungicide application.

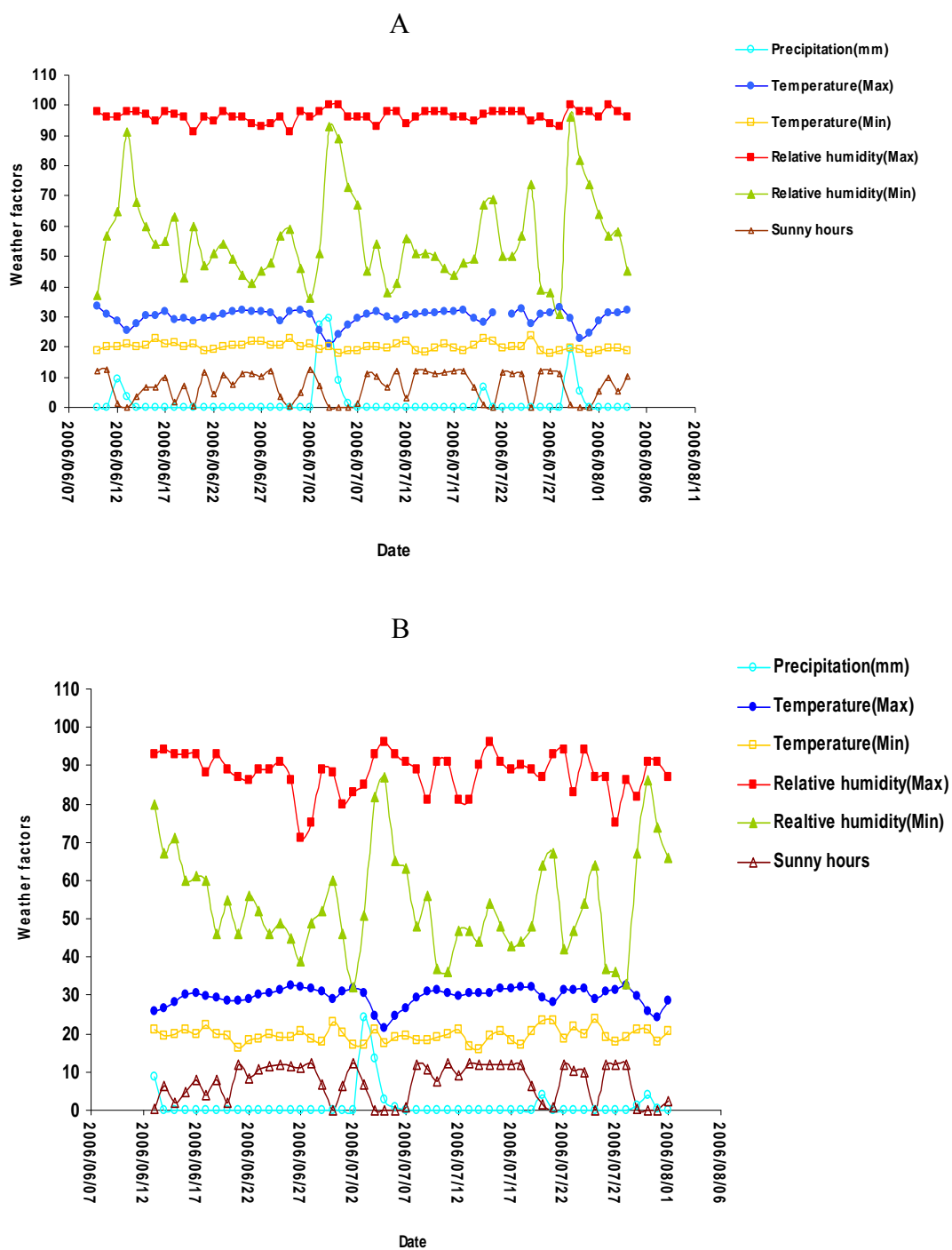

Figure 4 Weather factors fluctuations in Rasht (A) and Lahijan (B) in 2006. P, precipitation (mm), T, temperature (°C), RH, relative humidity (%), SH, sunny hours

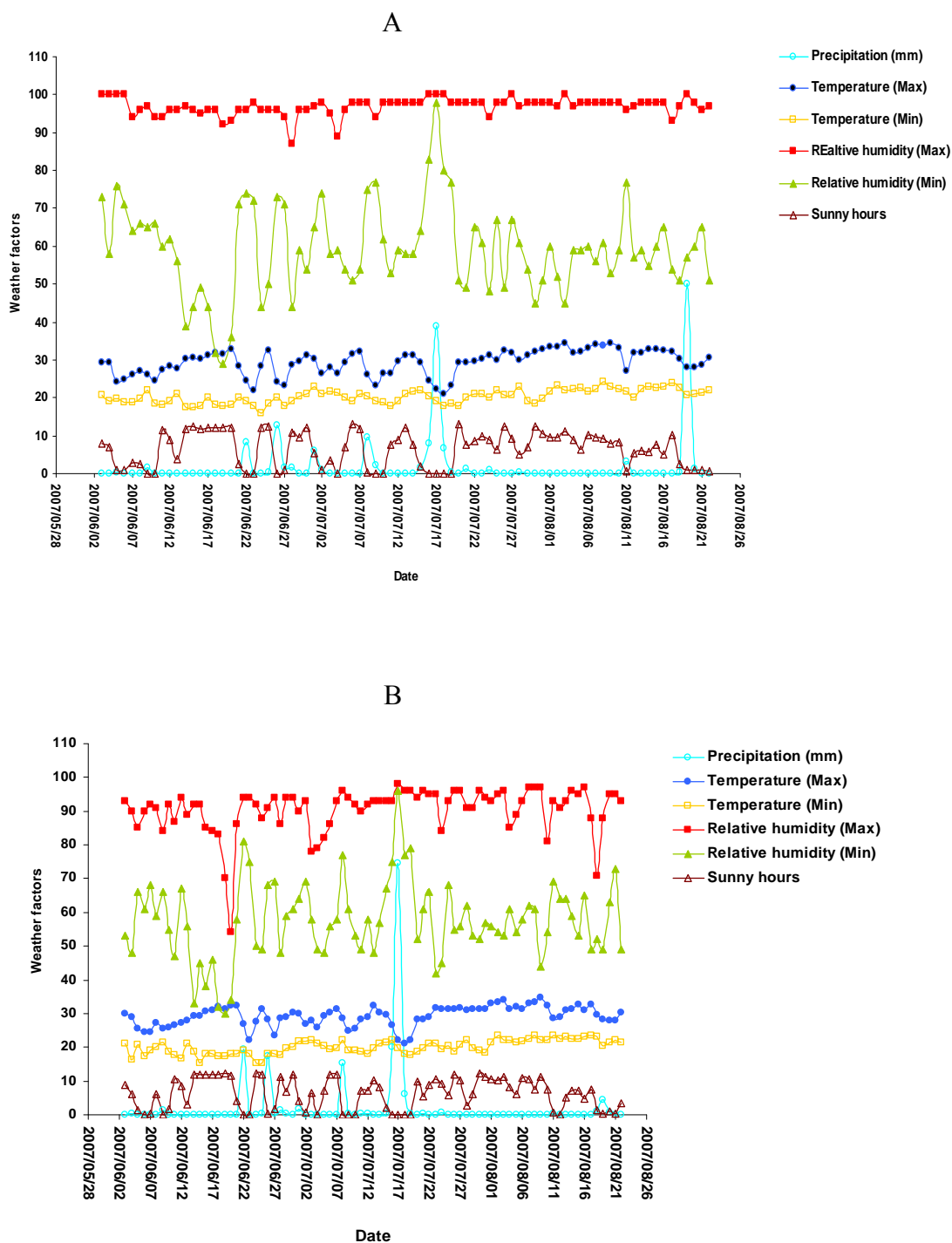

Figure 5 Weather factors fluctuations in Rasht (A) and Lahijan (B) in 2007. P, precipitation (mm), T, temperature (°C), RH, relative humidity (%), SH, sunny hours.

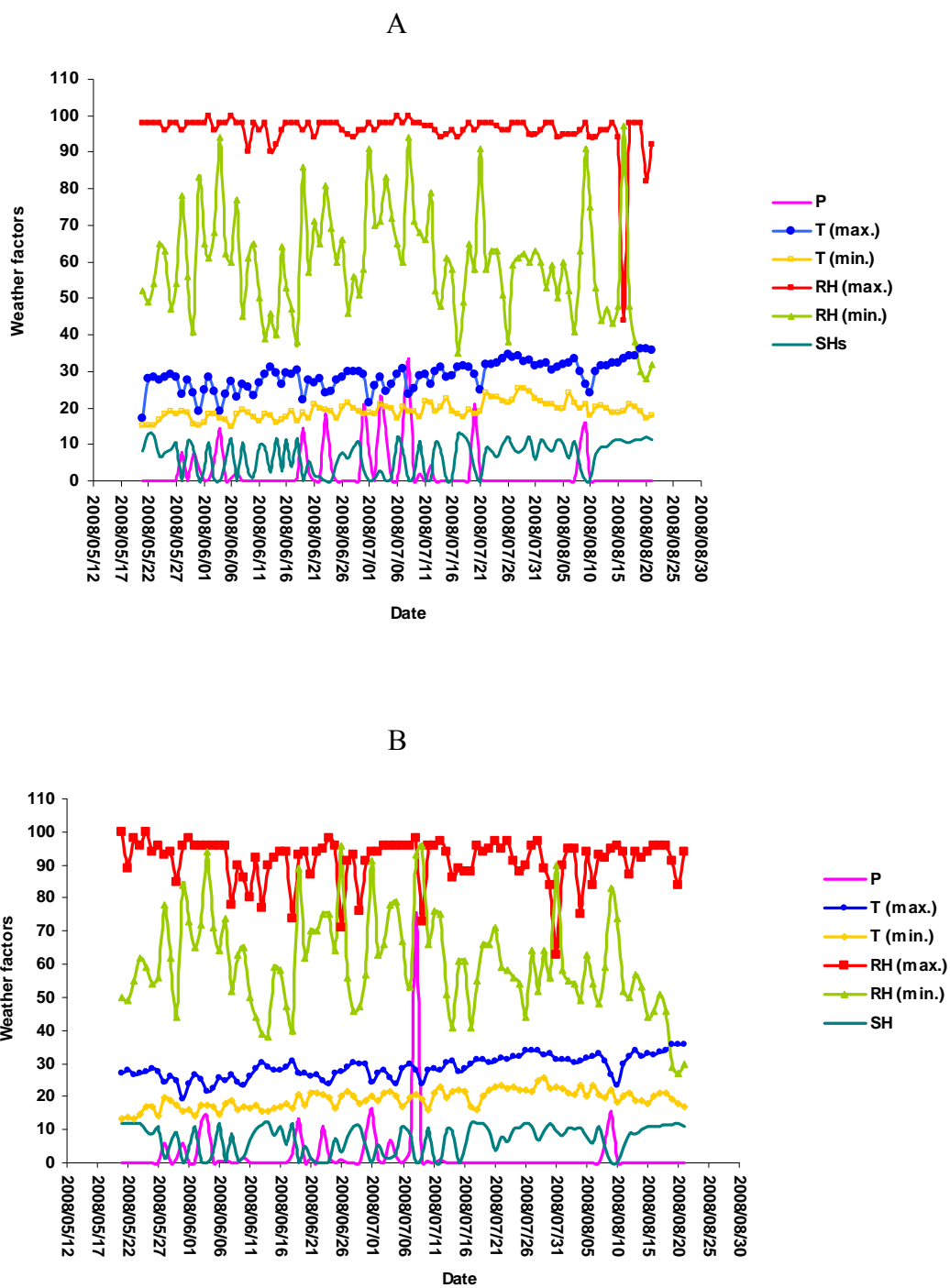

Figure 6 Weather factors fluctuations in Rasht (A) and Lahijan (B) in 2008. P, precipitation (mm), T, temperature (°C), RH, relative humidity (%), SH, sunny hours.

Our results using regression models showed that T_{\min} and RH_{\min} had linear combination with other variations in both regions and therefore were not used in correlation analysis. Based on the results (Table 1), meteorological factors including; P, RH_{avr} , T_{avr} and sunny hours are independent variables whereas P and sunny hours factors were not suitable for modeling by artificial neural network, the daily temperature and daily relative humidity were therefore used for modeling by ANN. Mousanejad *et al.*, (2009) have reported these meteorological factors as key factors for prediction of disease epidemics and our results are well in agreement with theirs.

In our results, the most important meteorological factors, indicated by backward variable selection using the ANN module were temperature and relative humidity during growing season. The scatter plot of *P. grisea* spores and meteorological factors of Rasht province are shown in Fig. 7.

Studies have shown that factors including the level of host susceptibility, date and space of transplanting, number of seedlings per hill, the amount and time of N fertilizer application, date of initial disease occurrence and its initial incidence or severity, the airborne spore population, environmental and weather factors such as soil and water temperatures, day and night relative humidity (RH), precipitation, hours of dew and its amount, leaf wetness duration, wind speed and direction and the amount of sunshine and applied fungicides (mode of action, date of application its duration) affect the blast disease. Introduction of a forecasting model needs predicting of spore population during growing season. Application of the meteorological factors for disease prediction and forecasting has previously been used by many researchers (Ono, 1965; Yoshino, 1971; El Refaei, 1977; Kingsolver *et al.*, 1984; Tsai and Su, 1984; Tsai, 1986).

The first studies on rice blast forecasting in Iran was carried out by Esmailpoor (1980).

In that study, blast severity was evaluated on different local cultivars based on mean temperature, relative humidity, dew and precipitation. The relationship between the blast severity and number of trapped spores using spore trap was also identified. Izadyar (1983) studied the relationship between weather conditions and the leaf and neck blast progress on different cultivars in Guilan province. He concluded that blast occurrence and progress in the field is highly related to favorable weather conditions during susceptible stages of these varieties and that the infection would not occur if the minimum night temperature was not higher than 19.5 °C. The relationship between the minimum temperature during transplanting to the initial disease occurrence in the field and the leaf blast severity was identified by Izadyar (1993) as well. He related the higher mean of minimum temperature during transplanting until initial disease occurrence to the higher severity of the leaf blast and also shorter period between transplanting and initial disease occurrence. In other words, there is a negative correlation between the mean minimum temperature and a temporal gap between transplanting and initial disease occurrence.

Padmanabhan (1965) and Calvero *et al.*, (1996) used minimum temperature and relative humidity for prediction of blast occurrence. Our results revealed that relative humidity and temperature are the most important meteorological factors and a suitable base for predicting spore population which are in accordance with the findings of other researchers. The relationship between meteorological factors and spore population are shown in Fig. 7. In this study, we introduce ANN model for prediction of spore population of rice blast before its actual occurrence in the field, more data are however needed for validation of the model. The approved model may then be used for timing of fungicide applications that will lead to reduction in pesticide usage in the field.

Table 1 Correlation matrix for variables used for modeling rice blast fungus spore population fluctuations in Rasht (A) and Lahijan (B).

A	P	Rh _{avr}	Rh _{max}	T _{avr}	T _{max}	Sun	spore
P	1.000						
Rh _{avr}	-0.2238	1.000					
Rh _{max}	-0.0384	-0.0594	1.000				
T _{avr}	0.1320	-0.4555	-0.1368	1.000			
T _{max}	-0.1018	0.5183	0.1621	-0.9398	1.000		
Sun	0.1617	0.1833	-0.1219	0.3824	-0.5005	1.000	
spore	0.0312	0.0230	0.0725	0.0749	-0.1069	0.1997	1.000

B	P	Rh _{avr}	Rh _{max}	T _{avr}	T _{max}	Sun	spore
P	1.000						
Rh _{avr}	-0.2513	1.000					
Rh _{max}	0.0767	-0.6604	1.000				
T _{avr}	0.1171	-0.4400	0.3631	1.000			
T _{max}	-0.1258	0.5345	-0.4143	-0.9360	1.000		
Sun	0.1231	0.1423	-0.0195	0.4989	-0.5762	1.000	
spore	0.0378	0.1001	-0.0824	-0.0626	0.0489	0.0917	1.000

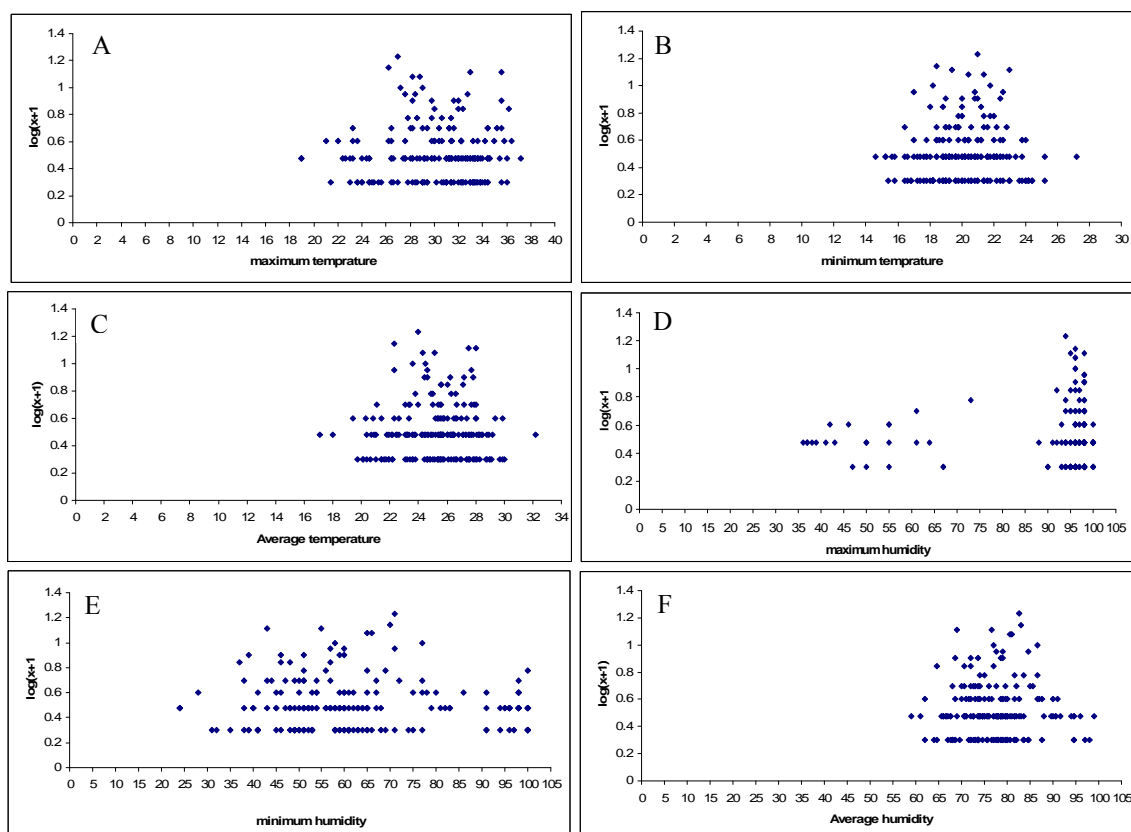

Figure 7 Frequency distribution and Matrix scatter plots between $\log(x + 1)$ transformed *Pyricularia grisea* spore population and Maximum Temperature (A), Minimum Temperature (B), Average Temperature (C), Maximum Humidity (D), Minimum Humidity (E) and Average Humidity (F) in Rasht.

References

- Amponsah, N. T., Jones, E. E., Ridgway, H. J., Jaspers, M. V. 2009. Rainwater dispersal of *Botryosphaeria* conidia from infected grapevines. *New Zealand Plant Protection*, 62: 228-233.
- Batchelor, W. D., Yang, X. B. and Tschanz, A. T. 1997. Development of a neural network for soybean rust epidemics. *Transactions of the American Society of Agricultural Engineers*, 40: 247-252.
- Bishop, C. 1995. *Neural networks for pattern recognition*. Oxford University Press.
- Calvero, S. B. Jr., Coakley, S. M. and Teng, P. S. 1996. Development of empirical forecasting models for rice blast based on weather factors. *Plant Pathology*, 45: 667-678.
- Chien, C. C., Tsai, W. H., Yang, Y. Z. and Liu, C. 1984. Studies on the epidemiology of rice blast disease in central areas of Taiwan. *Journal of Agricultural Research of China*, 33: 169-180.
- Chtioui, Y., Panigrahi, S. and Francle, L. A. 1999. Generalized regression neural network and its application for leaf wetness prediction to forecast plant disease. *Chemometrics Intelligence Laboratory System*, 48: 47-58.
- Cook, D. F. and Wolfe, M. L. 1991. A back-propagation neural network to predict average air temperature. *Artificial Intelligence Application*, 17: 1482-1487.
- De Wolf, E. D. and Francle, L. J. 1997. Neural networks that distinguish infection periods of wheat tan spot in an outdoor environment. *Phytopathology*, 87: 83-87.
- De Wolf, E. D. and Francle, L. J. 2000. Neural network classification of Tan spot and *Stagonospora* blotch infection periods in a wheat field environment. *Phytopathology*, 90: 108-111.
- El Refaei, M. J. 1977. Epidemiology of rice blast disease in the tropics with special reference to leaf wetness in relation to disease development. Ph. D. Thesis, Faculty of the Postgraduate School, Indian Agricultural Research Institute, New Delhi.
- Esmailpoor, M. H. 1980. Study on the environmental factors affecting rice blast. *Iranian Plant Disease and Pest Journal*, 48: 105-118.
- Fausett, L. 1994. *Fundamentals of Neural Networks*. New York: Prentice Hall.
- Francle, L. J. and Panigrahi, S. 1997. Artificial neural network models of wheat leaf wetness. *Agricultural and Forest Meteorology*, 88: 57-65.
- Francle, L. J., Panigrahi, S. and Pahdi, T. 1995. Neural network models that predict leaf wetness. (Abstr.) *Phytopathology*, 85: 1182.
- Grinn-Gofroń, A. and Strzelczak, A. 2008. Artificial neural network models of relationships between *Alternaria* spores and meteorological factors in Szczecin (Poland). *International Journal of Biometeorology*, 52: 859-868.
- Hashiguchi, S. and Kato, H. 1983. Quantificational method applied to the forecasting of the rice blast occurrence. *Plant Protection*, 37: 425-429.
- Haykin, S. 1994. *Neural Networks: A comprehensive foundation*. New York: Macmillan.
- Izadyar, M. 1983. The relation between weather conditions and rice leaf and neck blast development on different rice cultivars in Guilan province. *Proceeding of the 7th Iranian Plant Protection Congress*, Karaj, Iran. P. 85.
- Izadyar, M. 1993. Rice blast and its forecasting in Guilan province. *Proceeding of the 11th Iranian Plant Protection Congress*, Rasht, Iran. P. 64.
- Javan-Nikkhah, M. 2001. Study on genetic diversity of rice blast causal agent, *Pyricularia grisea* (Hebert) Barr, based on determination of VCGs, pathogenicity test and molecular approach in Guilan province. Ph. D. thesis, Tehran University, Tehran, Iran.
- Kim, C. H., Mackenzie, D. R. and Rush, M. C. 1988. Field testing a computerized forecasting system for rice blast disease. *Phytopathology*, 78: 931-934.
- Kim, C. H., Mackenzie, D. R. and Rush, M. C., 1987. A model to forecast rice blast disease based on weather indexing. *Korean Journal of Plant Pathology*, 3: 210-216.
- Kim, C. K. 1982. Improved methods for rice blast forecasting. *Korean Journal of Plant Protection*, 21: 19-22.

- Kim, C. K., Yoshino, R. and Mogi, S. 1975. A trial of estimating number of leaf blast lesions on rice plants on the basis of the number of trapped spores and wetting period of leaves. *Annual of the Phytopathology Society of Japan*, 41: 492-499.
- Kingsolver, C. H., Barksdale, T. H. and Marchetti, M. A. 1984. Rice blast epidemiology. *Bulletin of the Pennsylvania Agricultural Experiment Station*, 853: 1-33.
- Kono, T. 1977. Studies on the utilization method of electronic computer in the forecast work on disease and insect outbreak. 4. The system calculating forecast values using multiple regression analysis. *Bulletin of the Hiroshima Agricultural Experiment Station*, 39: 1-20.
- Kuribayashi, K. and Ichikawa, H. 1952. Studies on forecasting of the rice blast disease. *Specific Report of Nagano agricultural Experiment Station*, 13: 1-229.
- Lek, S. and Guegan, J. F. 1999. Artificial neural networks as a tool in ecological modeling, an introduction. *Ecological Modeling*, 120: 65-73.
- Luo, Y., Ma, Z., Reyes, H. C., Morgan, D., Michailides, T. J. 2007. Quantification of airborne spores of *Monilinia fructicola* in stone fruit orchards of California using real-time PCR. *European Journal of Plant Pathology*, 118: 145-154.
- Mousanejad, S., Alizadeh, A., Safaie, N. 2009. Effect of Weather Factors on Spore Population Dynamics of Rice Blast Fungus in Guilan Province. *Journal of plant Protection Research*, 49: 319-329.
- Muramatsu, Y. and Koyanagi, T. 1977. Attempts to utilize computers for forecasting rice diseases and pests. *Plant Protection*, 31: 59-63.
- Ono, K. 1965. Principles, methods and organization of rice disease forecasting. In: *The Rice Blast Disease*. pp. 173-194. The Johns Hopkins Press, Baltimore, Maryland.
- Padmanabhan, S. Y. 1965. Studies on forecasting outbreaks of blast disease of rice. 1. Influence of meteorological factors on blast incidence at Cuttack. *Proceeding of Indian Agricultural Society*, 62: 117-129.
- Patterson, D. 1996. *Artificial Neural Networks*. Singapore: Prentice Hall.
- Shimizu, S. 1980. Quantification analysis of variation of rice blast outbreak and its application to disease forecast. *Bulletin of the Agricultural Experiment Station Naga Agriculture Research Center*, 41: 1-137.
- Thai, C. N. and Shewfelt, R. L. 1991. Modeling sensory color quality of tomato and peach: Neural networks and statistical regression. *Transactions of the American Society of Agricultural Engineers*, 34: 950-955.
- Tsai, W. H. 1986. Prediction of rice leaf blast. 3. Meteorological variables and percentage of leaf area infected by *Pyricularia oryzae*. *Plant Protection Bulletin of Taiwan*, 26: 171-180.
- Tsai, W. H. and Su, H. J. 1984. Prediction of rice leaf blast. 1. Meteorological variables and the development of the number of lesions. *Journal of Agricultural Research of China*, 34: 71-78.
- Tsai, W. H. and Su, H. J. 1985. Prediction of rice leaf blast, The relationships of meteorological variables, conidial numbers and the development of the number of lesions. *Journal of Agricultural Research of China*, 34: 71-78.
- Uehara, Y. 1985. Regional classification of rice blast occurrence in Hiroshima prefecture by multivariate analysis. *Bulletin of the Hiroshima Agricultural Experiment Station*, 49: 19-30.
- Visen, N. S., Paliwal, J., Jayas, D. S. and White, N. D. G. 2002. Specialist neural networks for cereal grain classification. *Biosystems Engineering*, 82: 1515-159.
- Yang, X. B. and Batchelor, W. D. 1997. Modeling plant disease dynamics using neural networks. *Artificial Intelligence Application*, 11: 47-55.
- Yang, X. B., Batchelor, W. D. and Tschanz, A. T. 1995. A neural network model to predict soybean rust. (Abstr.) *Phytopathology*, 85: 1172.
- Yoshino, R. 1971. Ecological studies on the infection in rice blast epidemics. I. Infection rates and hyphal growth in epidermal cells. *Proceeding of Association Plant Protection. Hokuriku* 19: 14-17.

مدل سازی نوسانات جمعیتی *Pyricularia grisea* تحت تأثیر شرایط آب و هوایی با استفاده از شبکه عصبی مصنوعی در استان گیلان

شیده موجرلو، صدیقه موسی نژاد و ناصر صفایی*

گروه بیماری‌شناسی گیاهی، دانشکده کشاورزی، دانشگاه تربیت مدرس، تهران، ایران.

* پست الکترونیکی نویسنده مسئول مکاتبه: nsafaie@modares.ac.ir

دریافت: ۲۴ مهر ۱۳۹۱؛ پذیرش: ۷ اسفند ۱۳۹۱

چکیده: بیماری بلاست برنج که توسط قارچ *Pyricularia grisea* ایجاد می‌شود، یکی از بیماری‌های مهم این محصول در دنیا و ایران می‌باشد. به‌منظور بررسی ارتباط بین جمعیت اسپور و عوامل آب و هوایی، جمعیت اسپور با استفاده از تله اسپوری به‌صورت روزانه طی فصول زراعی ۱۳۸۵ تا ۱۳۸۷ در شهرستان‌های رشت و لاهیجان (استان گیلان) اندازه‌گیری شد. داده‌های هواشناسی شامل میزان بارش، حداقل و حداکثر دمای روزانه، حداقل و حداکثر رطوبت نسبی روزانه و میزان ساعات آفتابی بود که از ایستگاه هواشناسی که حدود ۵ کیلومتر با مزارع فاصله داشت، به‌دست آمد. ارتباط بین جمعیت اسپور و عوامل آب و هوایی به‌کمک نرم‌افزار Neurosolution 5.0 ارزیابی شد. داده‌های آب و هوایی و جمعیت اسپور به ترتیب به‌عنوان متغیر ورودی و خروجی در نظر گرفته شد. در این بررسی از شبکه عصبی پرسپترون چند لایه و مدل رگرسیون و تبدیل $\log(x + 1)$ برای جمعیت اسپور استفاده شد. ضریب همبستگی و میانگین مربعات خطا برای ارزیابی کارایی مدل به‌کار گرفته شد. نتایج نشان داد که، پارامتر ضریب همبستگی و آماره میانگین مربعات خطا برای شهرستان‌های رشت و لاهیجان به‌ترتیب ۰/۵۵، ۰/۰۳ و ۰/۱ و ۰/۰۳ می‌باشد. همچنین نتایج این تحقیق کارایی مدل به‌دست آمده با استفاده از شبکه عصبی مصنوعی در پیش‌بینی جمعیت اسپور با استفاده از فاکتورهای آب و هوایی را نشان می‌دهد، البته به داده‌های بیشتری برای اعتباریابی مدل نیاز می‌باشد. این اولین گزارش از مدل‌سازی ارتباط بین جمعیت اسپور و فاکتورهای آب و هوایی با استفاده از شبکه عصبی مصنوعی می‌باشد.

واژگان کلیدی: برنج، بلاست، پیش‌آگاهی، شبکه عصبی مصنوعی، *Pyricularia grisea*